

Manufactured by:



Charder Electronic Co., Ltd.

No.103, Guozhong Rd., Dali Dist., Taichung City, 412 Taiwan (R.O.C.)

Made in Taiwan

[www.oserio.com](http://www.oserio.com)

130-FEG113-001 05/2013

**oserio**<sup>®</sup> Body Fat Monitor  
Health is Beautiful

oserio Body Fat Monitor Instruction Manual – FEG-113 series

Thank you for selecting oserio series of Health Management Products.

This Instruction Manual will guide you through the setup procedures and outline the key features.



Please keep the instruction manual at hand all the time for future reference.

oserio®

Health conscious • Professional • Innovative

## Table of Contents

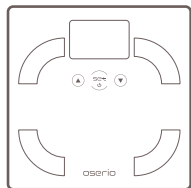

oserio Body Fat Monitor  
FEG-113 series

### 1 Before Using the Monitor

1.1 Overview	1
1.2 Battery Installation	2
1.3 Product Features	3
1.4 Introduction	5
1.5 Important Safety Notes	6
1.6 EMC Guidance and Manufacturer's Declaration	9
1.7 Used Symbol Description	16

### 2 Operating Instructions

2.1 Taking Weight Measurement Only	17
2.2 Setting User Profile	18
2.3 Measuring Body Composition	20
2.4 Viewing Measurement Values	22
2.5 Viewing Historical Values	24
2.6 Modifying User Profile	26
2.7 Error Message List	29

### 3 More Information

3.1 Care and Maintenance	30
3.2 Product Specification	31

## Before Using the Monitor

### 1.1 Overview

- ① LCD display
- ② Setting buttons\*
- ③ Platform
- ④ Feet
- ⑤ Battery Cover
- ⑥ Reset button\*\*

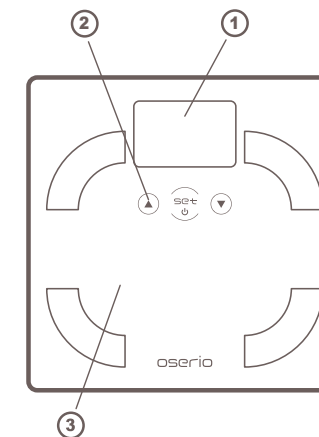

Front

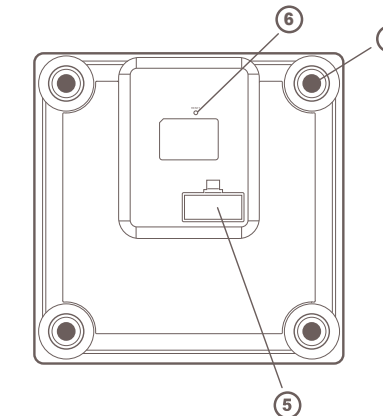

Rear

NOTE:

\* Press the button with your finger without gloves and humidity. And, keep any metal away from the buttons.

\*\*Press reset button for 3 seconds to erase all profiles and records.

## 1.2 Battery Installation

⚠ Please verify if the batteries are installed correctly

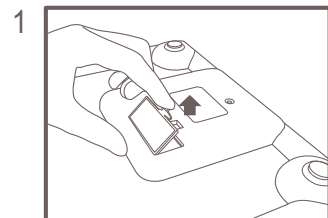

Open the battery cover

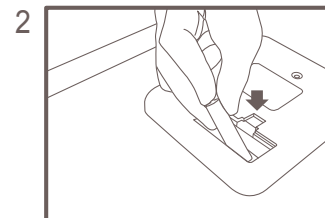

Install 4 "AAA" size batteries properly

## NOTE:

Measurements and user profiles will not be erased during battery replacement.  
Be sure that the polarity of the battery is set properly.

## 1.3 Product Features

1. Measure weight, body fat, BMI, visceral fat, basal metabolic rate(BMR) and muscle rate.
2. 4 users profile.
3. 7 historical values.
4. "Visitor Mode is for visitors using and the measurement reading will be erased from the memory.
5. Data reference from ***Body fatness and risk for elevated blood pressure, total cholesterol, and serum lipoprotein in children and adolescents American journal of public health***. After compared measurement value, indicator will shows "Low, Normal, High, Very High"

**Body Fat References** : Daniel P. Williams, Scott B. Going, Timothy G. Lohman, David W. Harsha, Satharnur R Srinivasan, Larry S. Webber, Gerald S. Berenson, *Body fatness and risk for elevated blood pressure, total cholesterol, and serum lipoprotein rations in children and adolescents American journal of public health, March 1992, Vol. 82, No.3*

**1.3 Product Features**

6. Large LCD display (90 x 60mm)
7. Simple button design
8. Full English interface
9. User friendly design with colorful and interesting face icons
10. Compact design

**1.4 Introduction**

**Product description:** This unit is measuring the user's body weight and to estimate the value of the Bio-Impedance body composition.

**Product use:** Body Fat, Visceral Fat, BMI, BMR, Muscle Rate and Body Weight.

**Measuring Principle:** Biological impedance Analysis (BIA) works together with such as gender, height, weight, age, other relevant factors, conversion of the user's body composition to determine whether the body is obese.  
(If input profile is incorrect, it would result in incorrect measurement values.)

**Recommended Measurement Times:** It is recommended to use this unit in the same environment and daily circumstances.

## 1.5 Important Safety Notes

1. People with an electronic medical implant, such as a pacemaker, should not use a Body Fat Monitor as it passes a low-level electrical signal through the body, which may interfere with its operation.
2. Pregnant women should use weight function only. All other functions are not intended for pregnant women.
3. Keep out of reach of young children.
4. Do not jumping on the unit platform.
5. Do not step on the edge of unit platform.
6. Person with disabilities or physically frail should be assisted by another person when using this unit.
7. Do not disassemble or modify the unit.
8. Using the batteries specify by the product specifications, polarities match the polarities of the battery compartment as indicated.

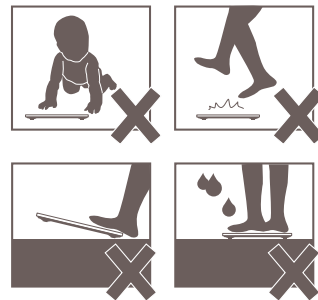

## 1.5 Important Safety Notes

9. Remove the batteries if the unit not be used for three months or longer.
10. If the display not shows, check the batteries.
11. Do not mix old and new batteries or different types of batteries to extend the life of the unit.
12. Do not use the unit on slippery surfaces such as tile floors or wet floors.
13. Place the unit in an area free from direct sunlight, heating equipment, high humidity or extreme temperature change.
14. Avoid excessive impact or vibration to the unit.
15. Never submerge in water. Use alcohol to clean the electrodes and glass cleaner (applied to a cloth first) to keep them shiny.
16. Place the unit on a hard, flat surface where there is minimal vibration to ensure safe and accurate measurement.



## 1.5 Important Safety Notes

17. Always remove your socks or stockings, and be sure the soles of your feet are clean before stepping on the measuring platform.
18. Properly dispose of batteries according to applicable local regulations.
19. Do not use this unit while operation transmitters (such as a cell phone) as this may affect your results.
20. This unit is intended for home use only. It is not intended for professional use in hospitals or other medical facilities.
21. These batteries should be kept away from small children.  
If swallowed , promptly seek medical assistance.
22. Expected Service Life: 5 years
23. IP (Ingress Protection) rating: IP21

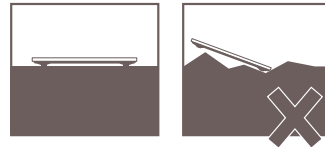

## 1.6 EMC Guidance and Manufacturer's Declaration

## Guidance and manufacturer's declaration-electromagnetic emissions

The FLG-351, FEG-113,FEG-123 is intended for use in the electromagnetic environment specified below. The customer or the user of the FLG-351, FEG-113,FEG-123 should assure that it is used in such an environment.

Emission test	Compliance	Electromagnetic environment-guidance
RF emissions CISPR 11	Group 1	The FLG-351, FEG-113,FEG-123 uses RF energy only for its internal function. Therefore, its RF emissions are very low and are not likely to cause any interference in nearby electronic equipment.
RF emissions CISPR 11	Class B	The FLG-351, FEG-113,FEG-123 is suitable for use in all establishments, including domestic establishments and those directly connected to the public low-voltage power supply network that supplies buildings used for domestic purposes.
Harmonic emissions IEC 61000-3-2	Not applicable	
Voltage fluctuations/flicker emissions IEC 61000-3-3	Not applicable	

## 1.6 EMC Guidance and Manufacturer's Declaration

Guidance and manufacturer's declaration-electromagnetic immunity			
The FLG-351, FEG-113,FEG-123 is intended for use in the electromagnetic environment specified below. The customer or the user of the FLG-351, FEG-113,FEG-123 should assure that it is used in such an environment.			
Immunity test	IEC 60601 test level	Compliance level	Electromagnetic environment-guidance
Electrostatic discharge(ESD) IEC 61000-4-2	± 6 kV contact ± 8 kV air	± 6 kV contact ± 8 kV air	Floors should be wood, concrete or ceramic tile. If floors are covered with synthetic material, the relative humidity should be at least 30%.
Electrical fast transient/burst IEC 61000-4-4	± 2kV for power supply lines + 1kV for input/output lines	± 2kV for power supply lines Not applicable	Mains power quality should be that of a typical commercial or hospital environment.
Surge IEC 61000-4-5	± 1kV line(s) to line(s) ± 2kV line(s) to earth	± 1kV differential mode Not applicable	Mains power quality should be that of a typical commercial or hospital environment.

Guidance and manufacturer's declaration-electromagnetic immunity			
Immunity test	IEC 60601 test level	Compliance level	Electromagnetic environment-guidance
Voltage Dips, short interruptions and voltage variations on power supply input lines IEC 61000-4-11	<5% UT(>95% dip in UT) for 0.5 cycle 40% UT(60% dip in UT) for 5 cycles 70% UT(30% dip in UT) for 25 cycles <5% UT(>95% dip in UT) for 5 s	Not applicable Not applicable Not applicable Not applicable	Mains power quality should be that of a typical commercial or hospital environment. If the user of the <b>FLG-351, FEG-113,FEG-123</b> requires continued operation during power mains interruptions, it is recommended that the <b>FLG-351, FEG-113,FEG-123</b> be powered from an uninterruptible power supply or a battery.
Power frequency (50/60 Hz) magnetic field IEC 61000-4-8	3 A/m	3 A/m	The <b>FLG-351, FEG-113,FEG-123</b> power frequency magnetic fields should be at levels characteristic of a typical location in a typical commercial or hospital environment.
<b>NOTE: UT is the a.c. mains voltage prior to application of the test level.</b>			



1.6 EMC Guidance and Manufacturer's Declaration

Guidance and manufacturer's			declaration-electromagnetic immunity	
Immunity test	IEC 60601 test level	Compliance level	Electromagnetic environment-guidance	
Conducted RF IEC 61000-4-6	3 Vrms 150 KHz to 80 MHz	Not applicable	<p><b>Portable and mobile RF communications equipment should be used no closer to any part of the FLG-351, FEG-113,FEG-123</b> including cables, than the recommended separation distance calculated from the equation applicable to the frequency of the transmitter.</p>	
Radiated RF IEC 61000-4-3	3 V/m 80MHz to 2.5 GHz	3 V/m	<p><b>Recommended separation distance:</b>  <math>d = 1.2 \sqrt{P}</math>  <math>d = 1.2 \sqrt{P}</math> 80MHz to 800 MHz  <math>d = 2.3 \sqrt{P}</math> 800MHz to 2.5 GHz                      Where P is the maximum output power rating of the transmitter in watts (W) according to the transmitter manufacturer and d is the recommended separation distance in metres (m).                       Field strengths from fixed RF transmitters, as determined by an electromagnetic site survey<sup>a</sup>, should be less than the compliance level in each frequency range<sup>b</sup>.</p> <p>Interference may occur in the vicinity of equipment marked with the following symbol:</p> 	

NOTE1:  
At 80 MHz and 800 MHz, the higher frequency range applies.

NOTE2:  
These guidelines may not apply in all situations. Electromagnetic propagation is affected by absorption and reflection from **structures, objects and people**.

---

A. Field strengths from fixed transmitters, such as base stations for radio (cellular/cordless) telephones and land mobile radios, amateur radio, AM and FM radio broadcast and TV broadcast cannot be predicted theoretically with accuracy. To assess the electromagnetic environment due to fixed RF transmitters, an electromagnetic site survey should be considered. If the measured field strength in the location in which the **FLG-351, FEG-113,FEG-123** should be observed to verify normal operation. If abnormal performance is observed, additional measures may be necessary, such as re-orienting or relocating the FLG-351, FEG-113,FEG-123.Over the frequency range 150 kHz to 80 MHz, field strengths should be less than 3 V/m.

B.

## 1.6 EMC Guidance and Manufacturer's Declaration

Recommended separation distance between portable and mobile RF communications equipment and the FLG-351, FEG-113,FEG-123			
<p>The FLG-351, FEG-113,FEG-123 is intended for use in an electromagnetic environment in which radiated RF disturbances are controlled. The customer or the user of the FLG-351, FEG-113,FEG-123 can help prevent electromagnetic interference by maintaining a minimum distance between portable and mobile RF communications equipment (transmitters) and the FLG-351, FEG-113,FEG-1231 as recommended below, according to the maximum output power of the communications equipment.</p>			
Rated maximum output power of transmitter (W)	Separation distance according to frequency of transmitter (m)		
	150 kHz to 80 MHz $d = 1.2 \sqrt{P}$	80 MHz to 800 MHz $d = 1.2 \sqrt{P}$	800 MHz to 2.5 GHz $d = 2.3 \sqrt{P}$
0.01	N/A	0.12	0.23
0.1	N/A	0.38	0.73
1	N/A	1.2	2.3
10	N/A	3.8	7.3
100	N/A	12	23

For transmitters rated at a maximum output power not listed above, the recommended separation distance  $d$  in meters (m) can be estimated using the equation applicable to the frequency of the transmitter, where  $p$  is the maximum output power rating of the transmitter in watts (W) according to the transmitter manufacturer.

NOTE1:  
At 80 MHz and 800 MHz, the separation distance for the higher frequency range applies.







NOTE2:  
These guidelines may not apply in all situations. Electromagnetic propagation is affected by absorption and reflection from structures, objects and people.

# 1

## Before Using the Monitor

### 1.7 Used Symbol Description

#### Explanation of the graphic symbols:

SN-135-00001	Designation of the serial number of every device, applied at the device. (Number as an example)		Carefully read this operation manual before setup and commissioning, even if you are already familiar with oserio scales.
	"Please note the accompanying documents" or "Observe operating instructions"		Dispose of old appliances separately from your household waste! Instead, take them to communal collection points.
 Chander Electronic Co., Ltd. No. 103, Guozhong Rd., Dali Dist., Tainan City, 412 Taiwan (R.O.C.)	Identification of manufacturer of medical product including address		Transport and storage temperature limit indicating the upper and the lower limit. (Transport and storage temperature on packaging)
	"Electro-medical appliance" with attachment for type BF		

# 2

## Operating Instructions

### 2.1 Taking Weight Measurement Only

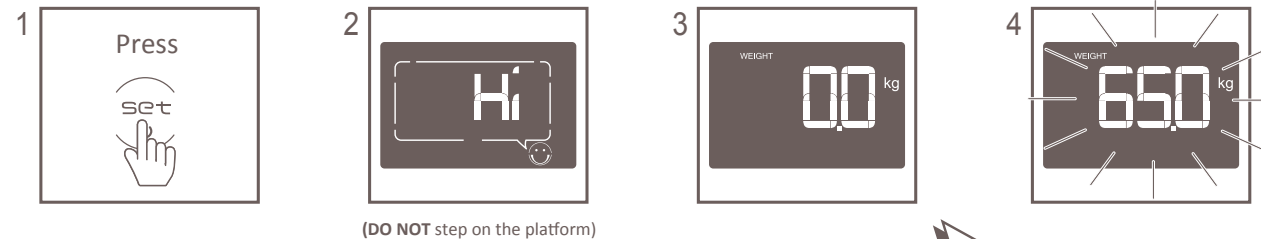

1. Press  to turn on.
2. Welcoming and running calibration.
3. Ready to take measurement while 0.0kg is shown.
4. Show weight reading.

Remain still and do not move until the measurement is completed.

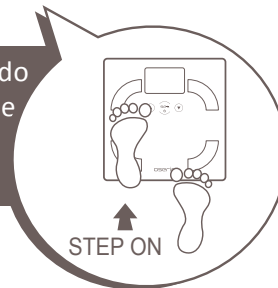

⚠ Place the unit on a hard, flat surface to avoid inaccurate measurement.

⚠ Press  to take another measurement.

#### Note:

The unit will shut down automatically if you do not touch any buttons within 20 seconds.

Press  2 seconds to turn off.

### 2.2 Setting User Profile

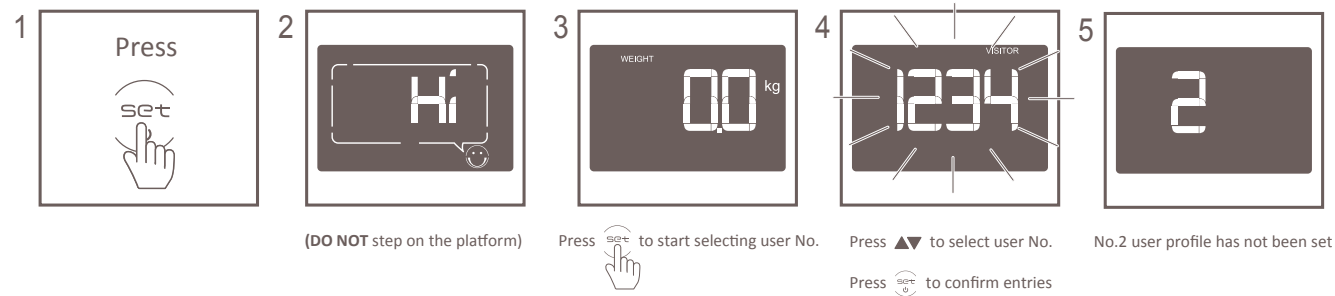

1. Press to turn on.

2. Welcoming and running calibration.

3. Calibration is completed.

Press to start selecting user No.

4. Select User No.

5. Show User No.

6. Set age

7. Set gender ( Male/ Female)

8. Set height

9. Setting completed while 0.0kg is shown.

**Note:**

The visitor's profile will not be kept in memory.

The unit will shut down automatically if you do not touch any buttons within 60 seconds.

Press for 2 seconds to turn off.

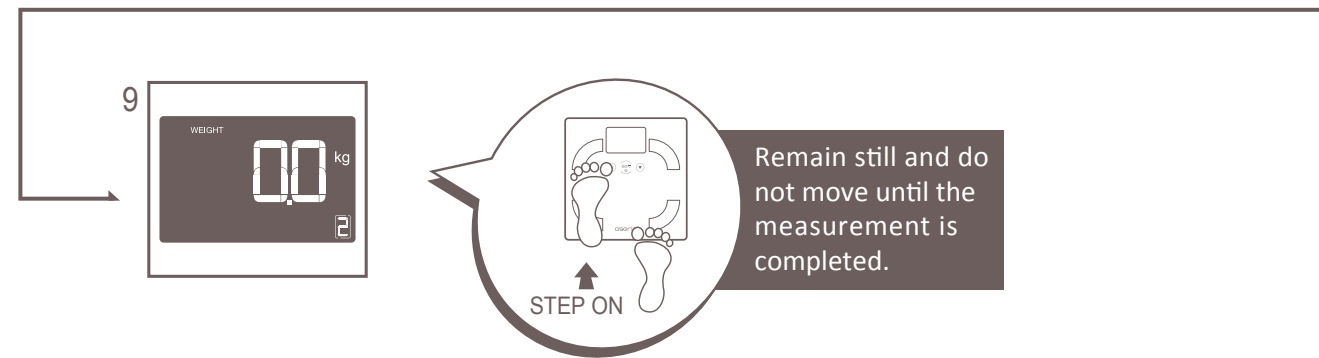
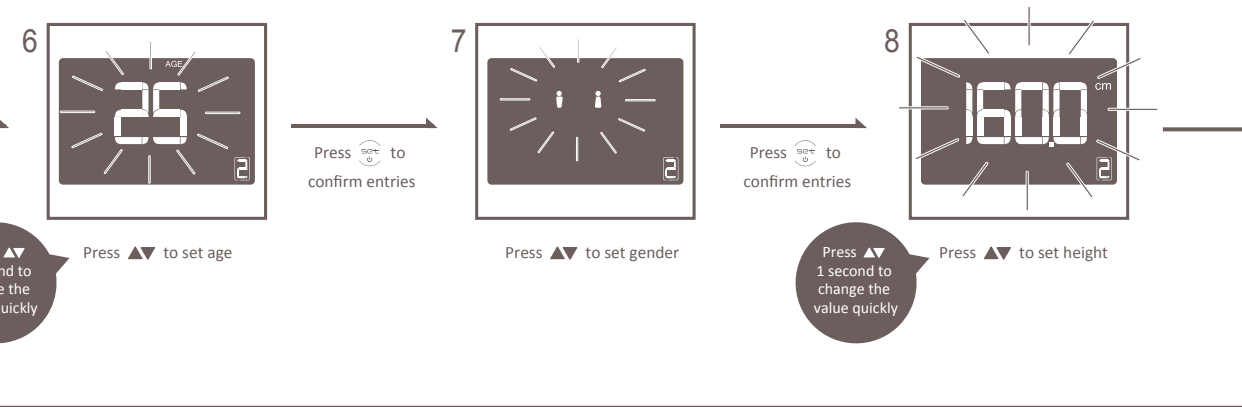

### 2.3 Measuring Body Composition

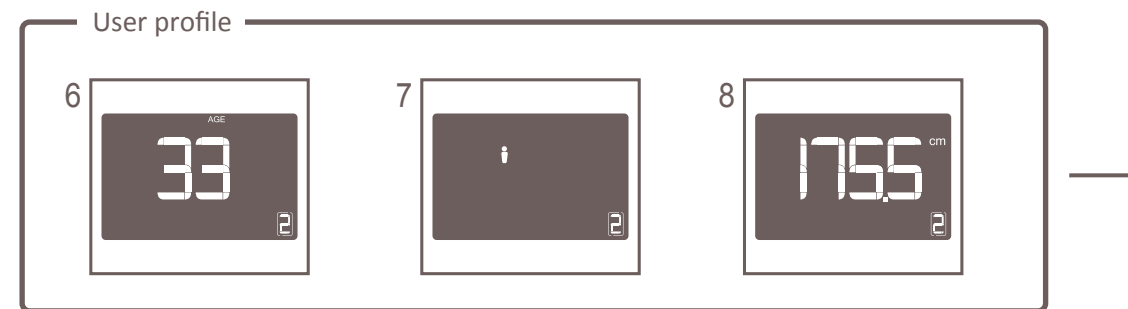
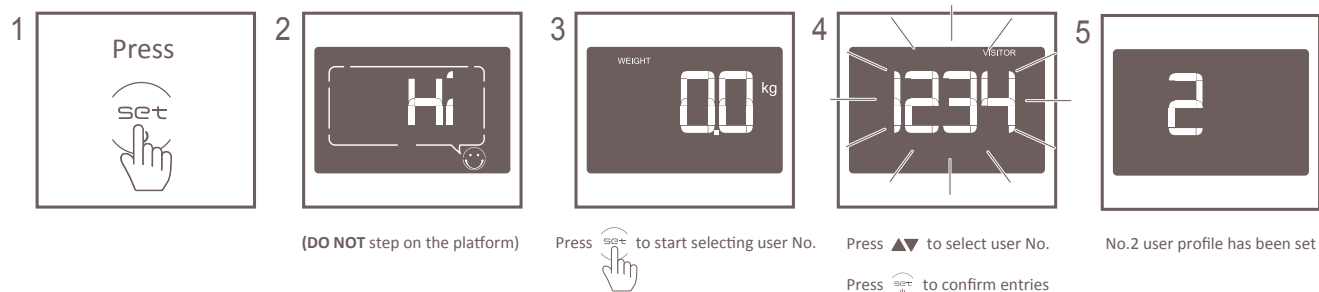

⚠ Refer to page 26 for modifying user profile.

1. Press to turn on.

2. Welcoming and running calibration.

3. Calibration is completed.

Press to start selecting user No.

4. Select User No.

5. Show User No.

6~8. Show user's profile. ( age, gender, and height)

9. Ready to take measurement while 0.0kg is shown.

**Note:**

The visitor's profile will not be kept in memory.

The unit will shut down automatically if you do not touch any buttons within 60 seconds.

Press for 2 seconds to turn off.

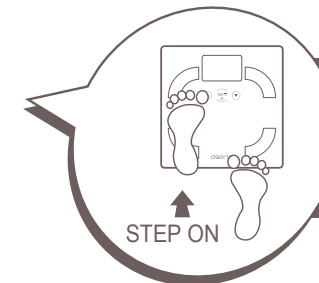
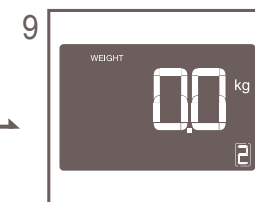

Remain still and do not move until the measurement is completed.

### 2.4 Viewing Measurement Values

✧ Select User No. or VISITOR and start measuring.

1. Take weight



2. Show weight

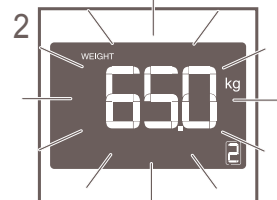

3. Measure body composition

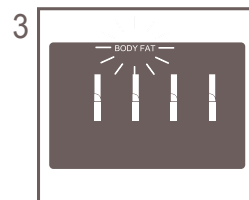

4. Show measurement values

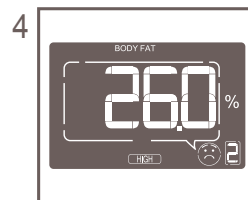

Remain still and do not move until the measurement is completed.

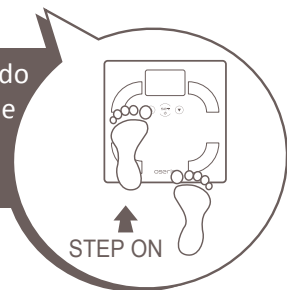

DO NOT Step off and remain still until body fat % is shown.



✧ Step off and view the values.

#### View user's reading after measuring body composition

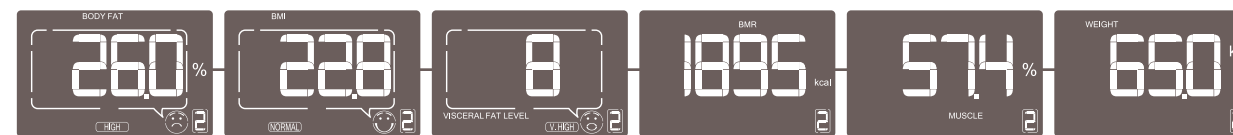

3 seconds

Press ▼ to show the next measurement value

1. Body Fat
2. Body Mass Index (BMI)
3. Visceral Fat Level
4. Basal Metabolic Rate (BMR)
5. Muscle Rate
6. Weight

**Note:**

Each measurement value last for 3 seconds.

The unit will shut down automatically if you do not touch any buttons within 30 seconds.

Press  for 2 seconds to turn off.

✧ Press  to select another user No. for taking another measurement.

### 2.5 Viewing Historical Values

✧ After user No. is selected, press ▲ to view historical values.

✧ While viewing user's reading after measuring body composition, press ▲ to view historical values.

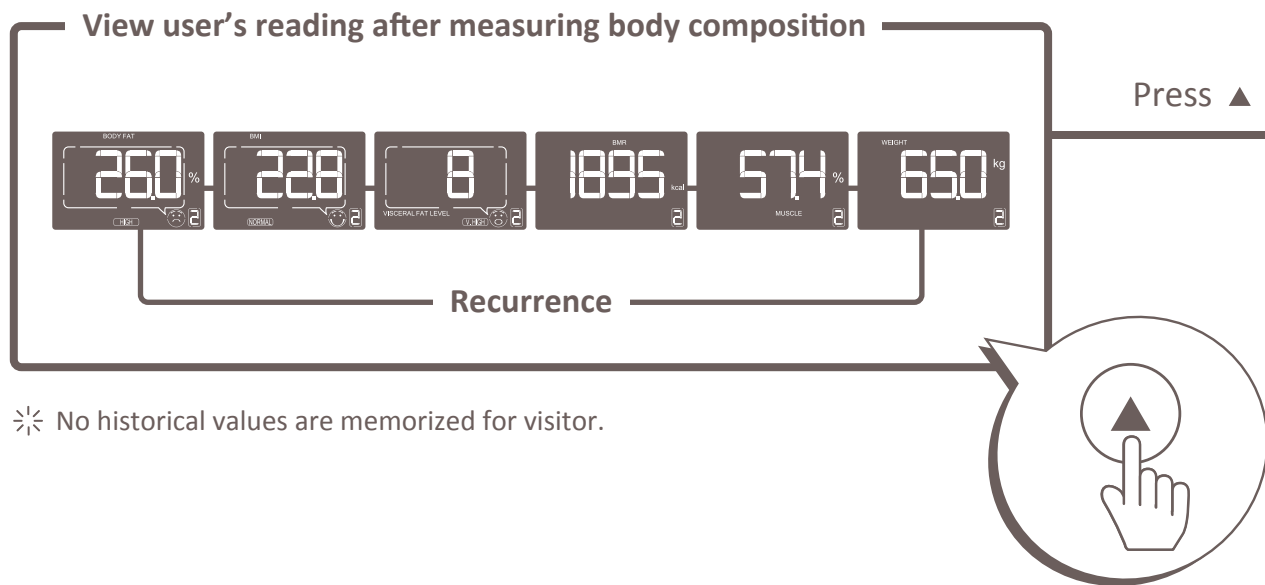

✧ No historical values are memorized for visitor.

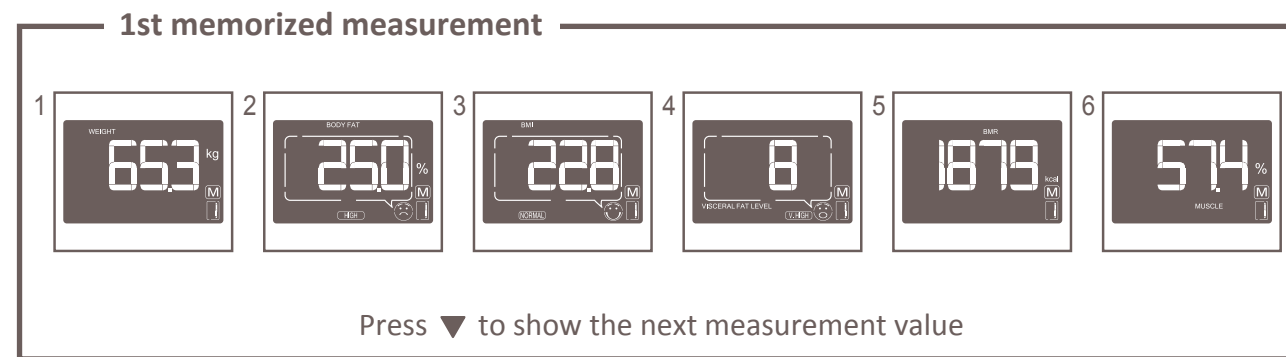

⋮

Press ▲ to toggle through last 7 memorized measurements.

1. 1st memorized weight
2. 1st memorized body fat
3. 1st memorized BMI
4. 1st memorized visceral fat
5. 1st memorized BMR
6. 1st memorized muscle rate

**Note:**

Press  for 2 seconds to turn

✧ Up to last 7 measurements

### 2.6 Modifying User Profile

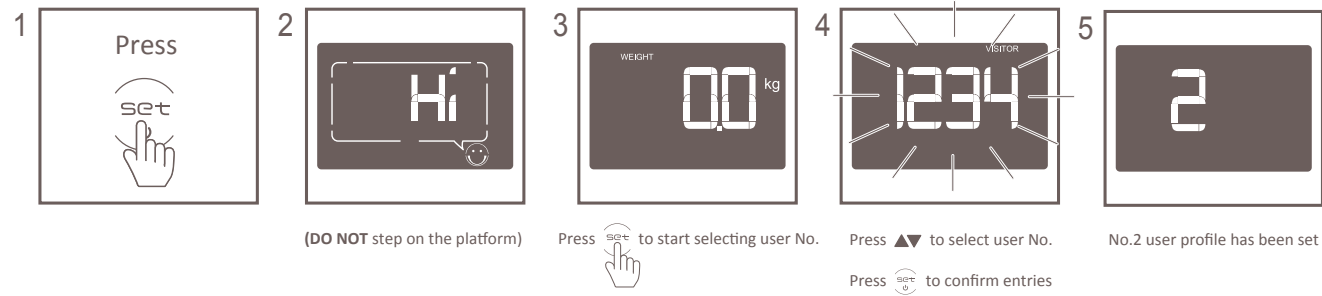

1. Press to turn on.

2. Welcoming and running calibration.

3. Calibration is completed.

Press to start selecting user No.

4. Select User No.

5. Show User No.

6. Press to modify user profile.

7. Modify age, gender, height item by item.

**Note:**

The unit will shut down automatically if you do not touch any buttons within 60 seconds.

Press for 2 seconds to turn off.

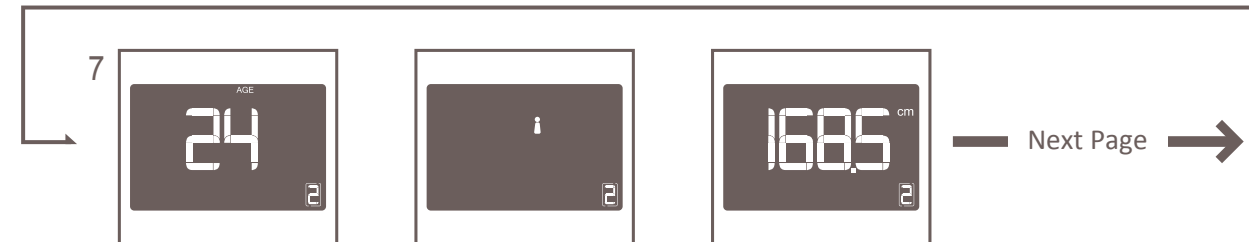
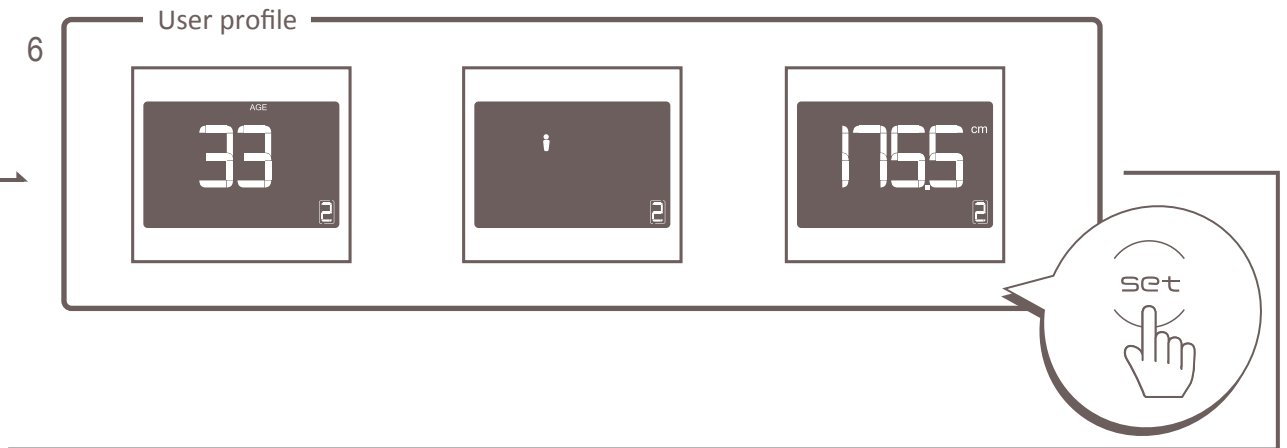

• Refer to page19 for setting user profile.

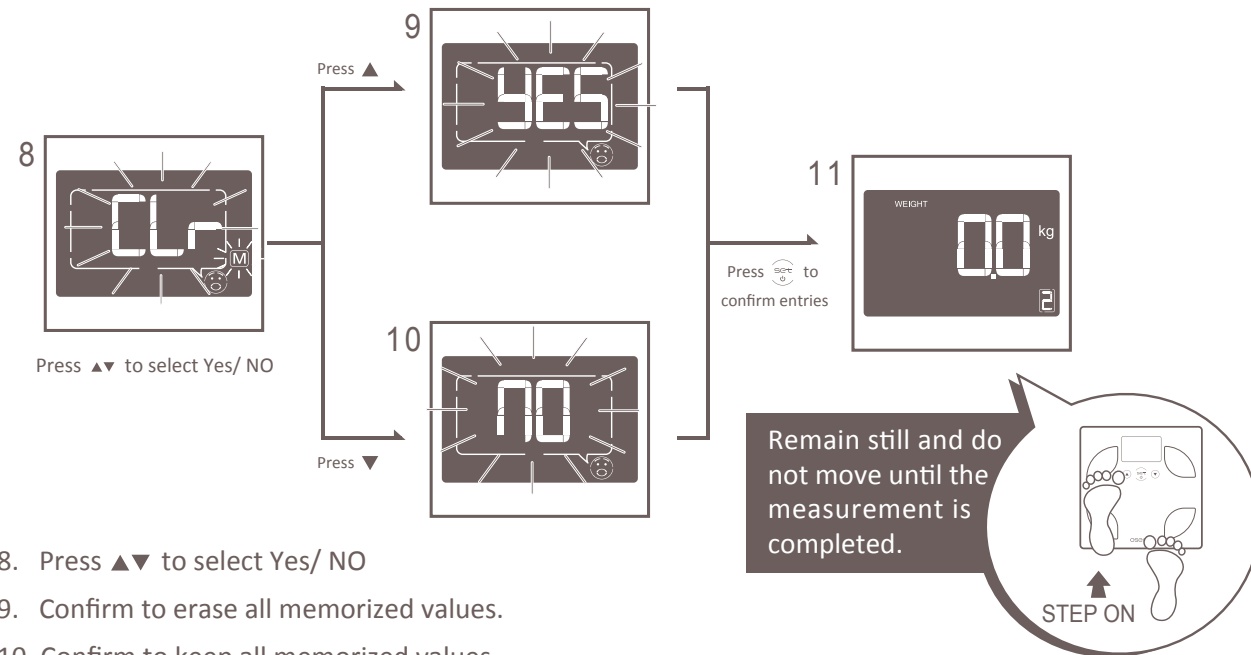

## 2.6 Modifying User Profile

**Note:**

Yes: Erase all memorized values of the stated user.

No: Modify stated user's profile only and keep all the memorized values.

## 2.7 Error Message List



The product is low power but still workable while flickers.



Replace batteries immediately while "LO" appears.



Overloading or loading is unbalanced within 1 minute. Please stand still during measurement.



The value of body fat is beyond the product specification.



The value of visceral fat is beyond the product specification.

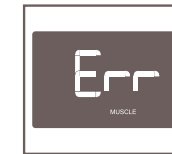

The value of muscle rate is beyond the product specification.



EEPROM is inactive, please reset user profile or contact oserio customer service.

# 3

## More Information

### 3.1 Care and Maintenance

1. Store the unit in a safe and dry location.
2. Avoid place on the aisle, to avoid accidentally tripped over pedestrians.
3. Never submerge in water.
4. Do not expose the unit to direct sunlight, extreme hot or cold temperatures or high humidity.
5. Avoid contact with corrosive chemicals or gas.
6. Clean the unit with a soft dry cloth for daily use.
7. Wipe the platform and display using clean soft cloth.
8. Do not use benzene, detergents or gasoline to clean the unit.
9. Avoid rough, sticking cloth, to prevent scratching the platform and screen panels.
10. Prevent water infiltration affecting the measurement accuracy.

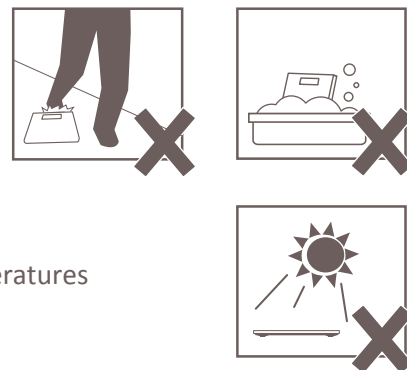

# 3

## More Information

### 3.2 Product Specification

Model	OSERiO Body Fat Monitor FEG-113		
Power Supply	4 AAA batteries	Weight	Approx. 1.6kg
Setting Range	Age:10~80 Gender: Male/Female Height: 100~199.5cm		
External Dimensions	Main unit: 285mm(d) x 285mm(w) x 25mm(h)		LCD: 93mm(d) x 60mm(w)
Operating Environment Limit	Temperature 5°C to 35°C Humidity 30% to 85% RH	Storage Environment Limit	Temperature -20°C to 60°C Humidity 10% to 95% RH
Weight Accuracy	0~40kg : ±0.4 kg , 40~150kg : ±1%	Memory	4 users and 1 visitor, 7 historical values
Display Content	Weight: 5 ~ 150kg, Graduation: 0.1kg Body Fat: 5.0 ~ 50.0%, Graduation: 0.1% Body Fat Status Category: Low/Normal/High/Very High Visceral Fat Level: Level 1~9 with 1 level increment Visceral Fat Status Category: 1~3(Normal)/4~6(High)/7~9(Very High) BMI: 0.0~150.0, Graduation: 0.1 Muscle Rate: 0.0~100.0%, Graduation: 0.1% BMR: 385~3999 kcal, Graduation: 1 kcal		
Accessories	Manual, Warranty card		

- Note:**
1. Body fat measurement is for users age 10~80.
  2. Specifications may be changed without prior notice.